

ILLUSTRATED PARTS LIST

MODEL NUMBER M65B5SD

PRODUCT NUMBER 961 41 00-03

MFG. ID. NUMBER 96141000301

ROTARY LAWN MOWER - - MODEL NUMBER M65B53SD (96141000301) PRODUCT NUMBER 961 41 00-03

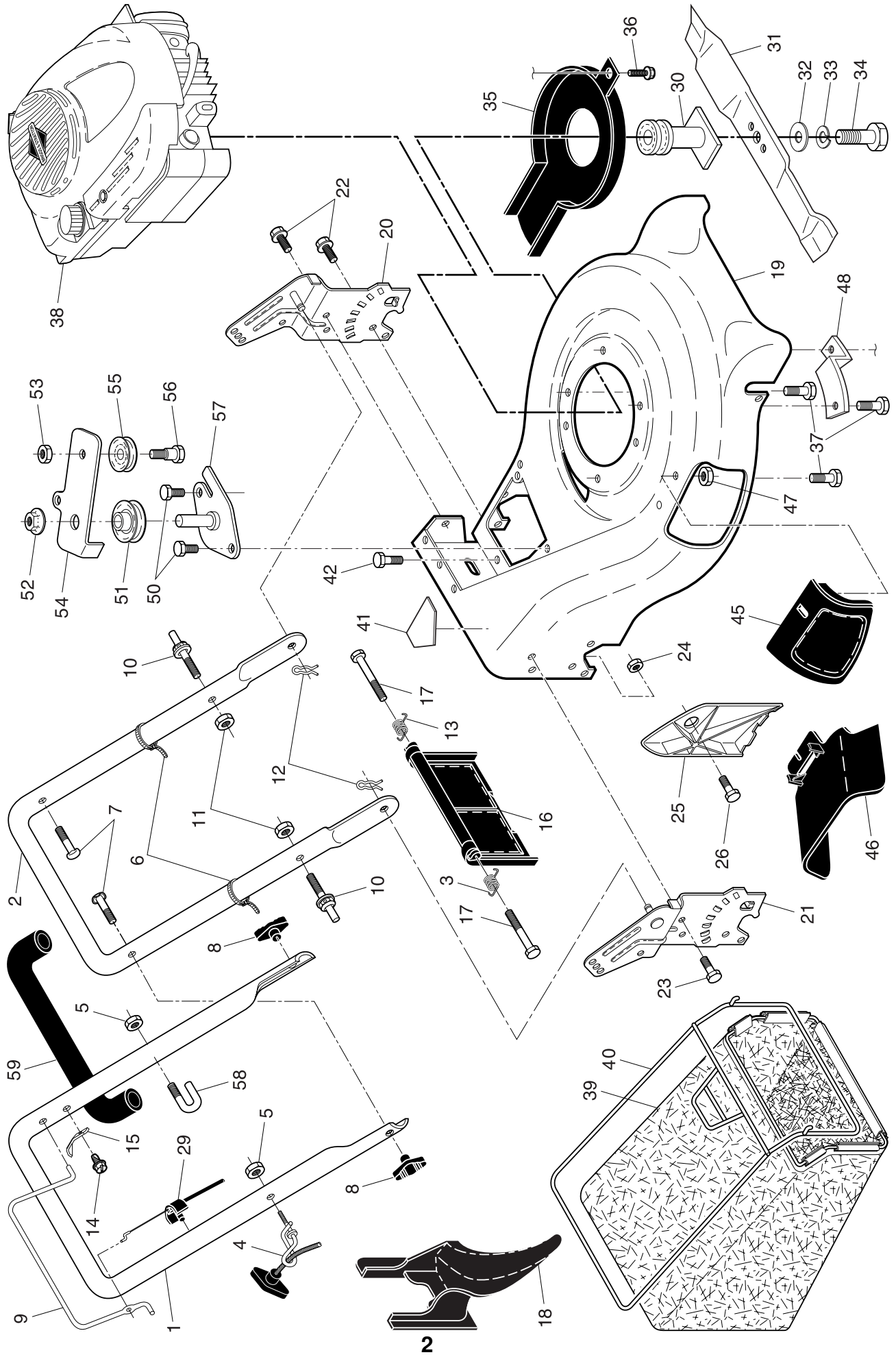

ROTARY LAWN MOWER - - MODEL NUMBER M65B53SD (9614100301) PRODUCT NUMBER 961 41 00-03

KEY NO.	PART NO.	DESCRIPTION	KEY NO.	PART NO.	DESCRIPTION
1	532 40 31-96	Handle, Upper (Includes Foam Grip)	31	532 19 93-77	Blade, 21"
2	532 19 60-05	Handle, Lower	32	532 85 10-74	Washer
3	532 18 60-53	Spring, Rear Door, RH	33	532 85 02-63	Washer, Lock
4	532 19 47-88	Rope Guide	34	532 85 10-84	Bolt, Hex Head
5	532 13 20-04	Nut, Hex, with Lockwasher Insert 1/4-20	35	532 18 87-86	Debris Shield
6	532 06 64-26	Wire, Tie	36	532 19 23-25	Screw, Machine #8
7	532 19 15-74	Bolt, Handle 5/16-18 x 1.75	37	532 15 04-06	Bolt, Engine
8	532 08 76-92	Knob, Handle	38	- - -	Engine, Briggs & Stratton, Model Number 124K02 (Order Parts From Engine Manufacturer)
9	532 19 84-64	Control Bar			Grassbag
10	532 18 88-21	Bolt, Carriage	39	532 19 49-68	Frame, Grassbag
11	873 93 05-00	Nut, Hex, Centerlock 5/16-18	40	532 19 46-44	Danger Decal
12	532 05 17-93	Hairpin, Cotter	41	532 18 21-66	Screw
13	532 18 60-52	Spring, Rear Door, LH	42	532 05 45-83	Door, Mulcher
14	532 75 06-34	Screw	45	532 19 13-41	Discharge Deflector
15	532 12 51-62	Bracket, Upstop	46	532 19 12-10	Nut, Hex
16	532 19 05-74	Rear Door	47	532 08 83-49	Mounting Bracket, Debris Shield
17	532 18 41-93	Bolt, Rear Door	48	532 19 09-39	Screw
18	532 19 81-70	Plug, Mulcher	50	532 05 78-08	Pulley Assembly
19	532 19 49-70	Kit, Housing	51	532 19 37-91	Flange Nut
20	532 19 40-29	Handle Bracket Assembly, LH	52	532 14 52-12	Locknut, Hex
21	532 19 40-31	Handle Bracket Assembly, RH	53	532 15 55-52	Idler Arm
22	532 15 00-78	Screw, Hex Washer Head	54	532 19 68-12	Idler Pulley
23	532 16 31-83	Bolt, Hex Head 5/16-18 x 5/8	55	532 16 60-43	Shoulder Bolt
24	873 80 05-00	Locknut, Hex	56	532 16 08-29	Bracket Assembly
25	532 16 13-33	Baffle, Side	57	532 19 33-15	Clip, Packaging
26	532 16 34-09	Screw #12 x 5/8	58	532 18 20-03	Grip, Foam
29	532 19 12-21	Cable, Engine Zone Control	59	532 18 63-62	Warning Decal (not shown)
30	532 18 91-79	Blade Adapter / Pulley	- -	532 18 21-34	Operator's Manual, European
			- -	532 40 36-16	

NOTE: All component dimensions given in U.S. inches. 1 inch = 25.4 mm. **IMPORTANT:** Use only Original Equipment Manufacturer (O.E.M.) replacement parts. Failure to do so could be hazardous, damage your lawn mower and void your warranty.

ROTARY LAWN MOWER - - MODEL NUMBER M65B53SD (96141000301) PRODUCT NUMBER 961 41 00-03

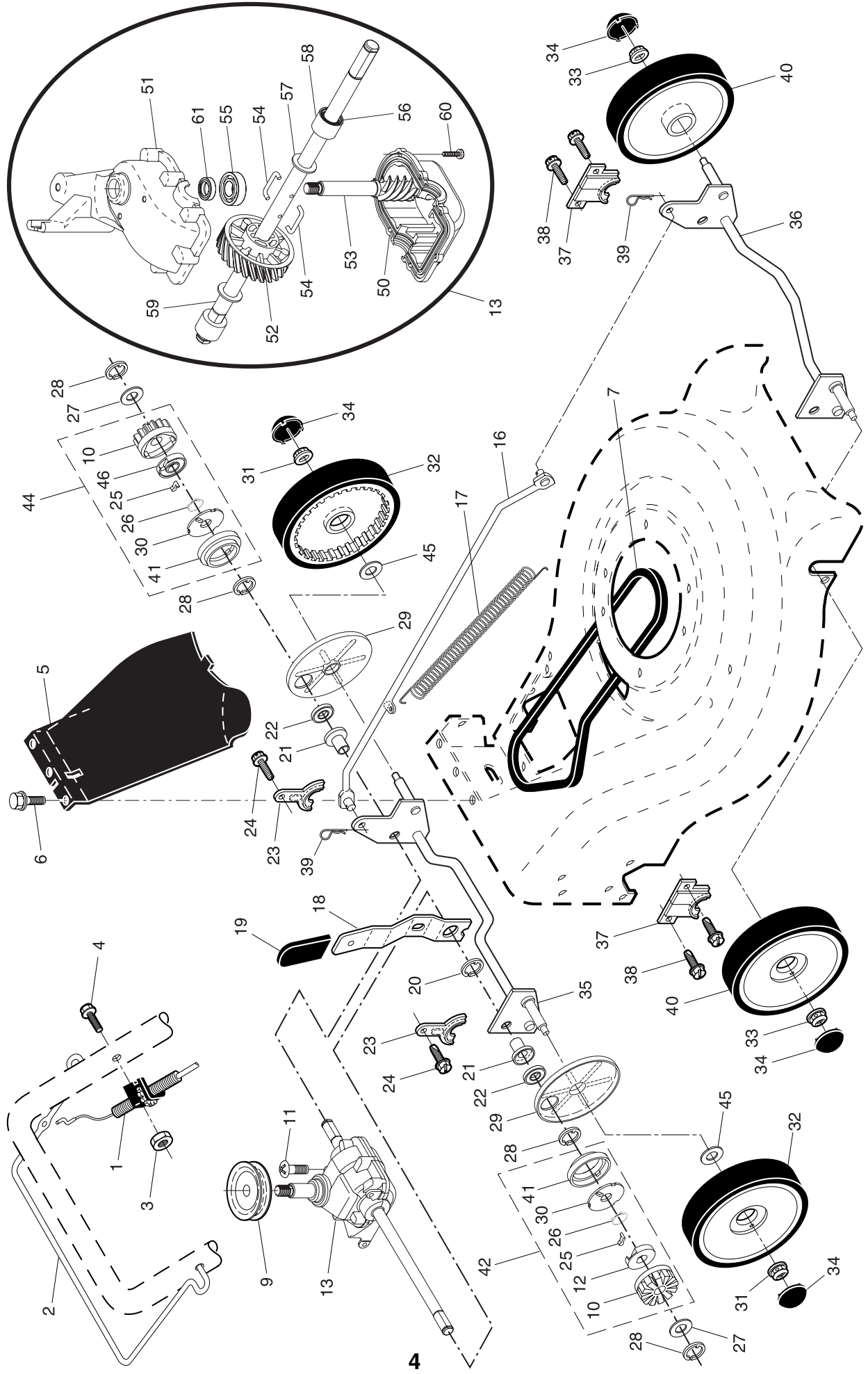

ROTARY LAWN MOWER - - MODEL NUMBER M65B53SD (9614100301) PRODUCT NUMBER 961 41 00-03

KEY NO.	PART NO.	DESCRIPTION	KEY NO.	PART NO.	DESCRIPTION
1	532 18 91-81	Drive Control Assembly, Vari-Speed, with Cable	32	532 18 07-74	Wheel & Tire Assembly, Rear (Driven) 9 x 2
2	532 19 84-53	Control Bar, Drive	33	532 08 39-23	Nut, Hex, Flangelock 3/8-16
3	532 19 17-30	Nut, Hex	34	532 16 43-78	Hubcap
4	532 18 56-81	Screw	35	532 19 60-16	Shaft Assembly, Rear
5	532 40 28-07	Cover Drive	36	532 19 95-14	Shaft Assembly, Front
6	532 75 06-34	Screw, Threaded, Rolled #10-25 x .50	37	532 16 14-63	Retainer, Front Shaft
7	532 18 22-12	V-Belt	38	532 16 34-09	Screw #12 x 5/8
9	532 19 41-28	Pulley, Drive	39	532 70 02-79	Clip, Retainer
10	532 17 51-03	Pinion, Gear	40	532 15 03-39	Wheel & Tire Assembly, Front 8 x 2
11	532 18 76-53	Screw	41	532 17 51-01	Seal, Friction
12	532 17 51-02	Retainer, Drive, RH	43	532 18 83-31	Pinion Assembly, RH
13	532 18 86-45	Gearcase Assembly, Complete	44	532 18 83-30	Pinion Assembly, LH
16	532 16 15-84	Rod, Connecting	46	532 17 51-05	Retainer, Drive, LH
17	532 16 16-02	Spring, Extension	47	532 06 77-25	Washer, Flat 1/2
18	532 19 61-62	Spring, Selector	50	532 18 75-30	* Case, Lower
19	532 19 00-69	Knob, Selector Spring	51	532 18 75-31	* Case, Upper
20	812 00 00-22	E-Ring 7/8	52	532 18 75-32	Gear, 24 Teeth
21	532 16 33-65	Bearing Support	53	532 18 75-33	Shaft, Input
22	532 16 99-11	Bearing, Ball	54	532 18 35-05	Wire, Formed
23	532 16 45-55	Retainer, Drive Assembly, Stamped	55	532 18 35-06	Bearing, Ball
24	532 05 78-08	Screw, Hex Head, Tapping 1/4-20 x .75	56	532 18 35-08	Seal, Output Shaft
25	532 17 50-98	Pawl	57	532 18 35-09	Washer
26	532 18 82-91	Spring, Torsion	58	532 18 35-11	Bushing
27	532 05 21-60	Washer, Shim (as required)	59	532 19 12-49	Shaft, Output
28	812 00 00-58	E-Ring 7/16	60	532 18 35-13	Screw
29	532 18 94-03	Cover, Dust, Wheel	61	532 18 35-14	Seal, Input Shaft
30	532 17 51-04	Disc, Drive			
31	532 14 52-12	Nut, Hex			

* Use Dow Corning #709 to reseal Gear Case Halves.

NOTE: All component dimensions given in U.S. inches. 1 inch = 25.4 mm. **IMPORTANT:** Use only Original Equipment Manufacturer (O.E.M.) replacement parts. Failure to do so could be hazardous, damage your lawn mower and void your warranty.